

# Birlea

Suppliers of inspiration

## Assembly Instructions

---

*Thank you* for  
purchasing a  
Birlea product.

For a chance to win a *Love 2 Shop* voucher simply post a picture of your new product on your preferred social channels tagging Birlea Furniture and using the hashtag **#ShareYourStyle** and **#Birlea**. One winner will be selected at random each month.

*To view our full terms and conditions please visit our website. [www.birlea.com](http://www.birlea.com)*

---

### **Are you happy with your purchase?**

**Yes:** That's great, we would love to hear more from you. Please leave us a review on our social media channels or Trustpilot. Your feedback will be greatly appreciated.

**No:** If for any reason there is something missing, indifferent or incorrect with your order, please contact the retailer you purchased the item from. We will work with the retailer to resolve your issue as quickly as possible.



[www.birlea.com](http://www.birlea.com)

## **ASSEMBLY INSTRUCTIONS** **CROXLEY 1 DRAWER RATTAN BEDSIDE**

**IMPORTANT : READ THESE INSTRUCTIONS CAREFULLY BEFORE ATTEMPTING TO ASSEMBLE OR USE YOUR CROXLEY 1 DRAWER RATTAN BEDSIDE.**

**PLEASE KEEP THESE INSTRUCTIONS FOR FUTURE REFERENCE.**

### **ASSEMBLY:**

Assembly should be carried out with this item laying flat, not standing upright.

Assemble on a soft, clean surface to prevent damages.

To erase the numbers printed on the pieces, use the rubber inside the accessories pack.

### **HEALTH & SAFETY:**

DO NOT use this product if any parts are missing, damaged or worn.

DO NOT use this product unless all fixings are secured.

Always use on a level, even surface.

### **CARE & MAINTENANCE:**

Periodically check all screws & fixings to ensure they are secure.

DO NOT push this product as this will cause damage.

Always lift this product with two people to repositions.

Keep any sharp objects away from this product.

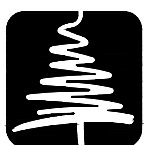
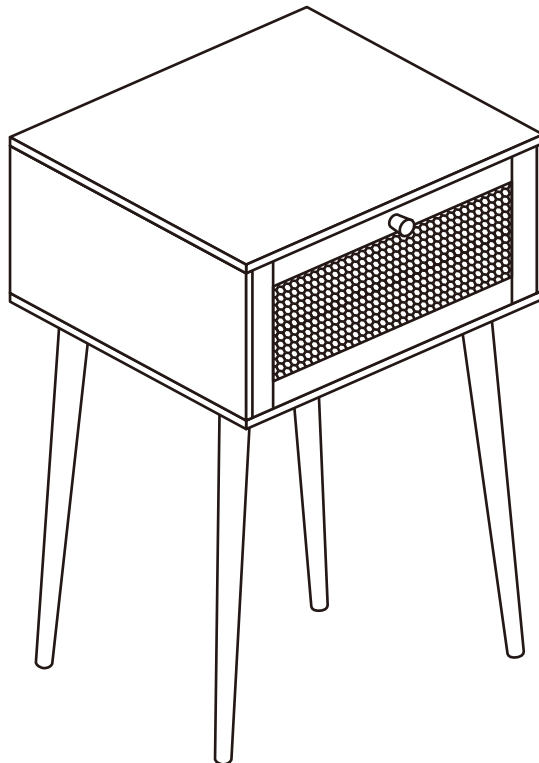

**Birlea**





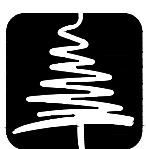
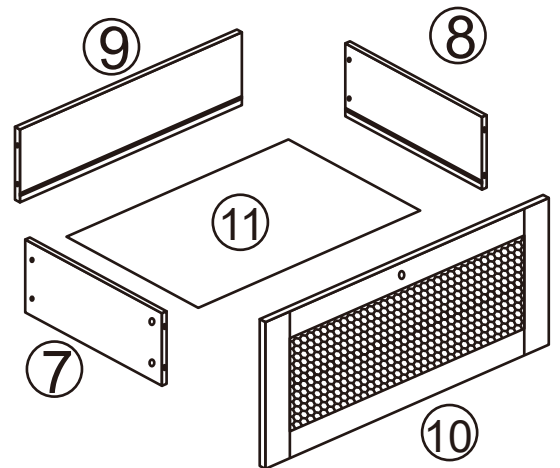
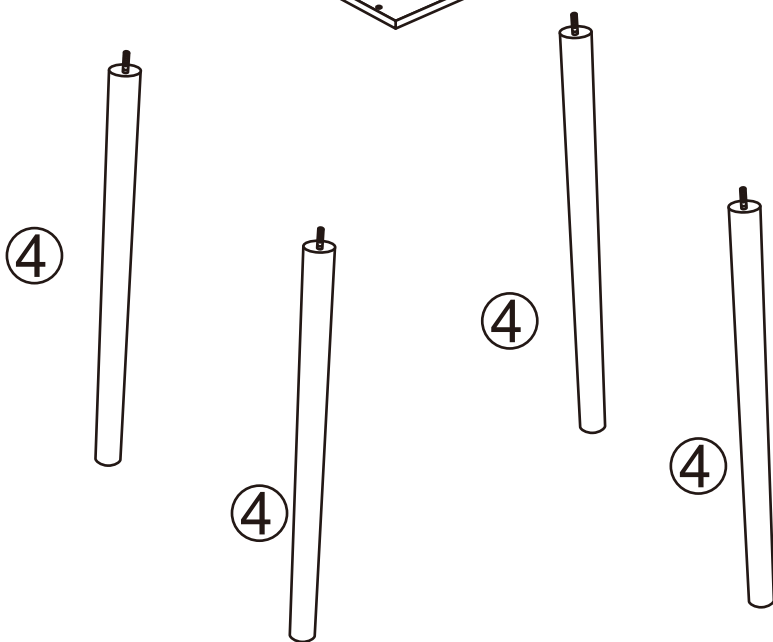
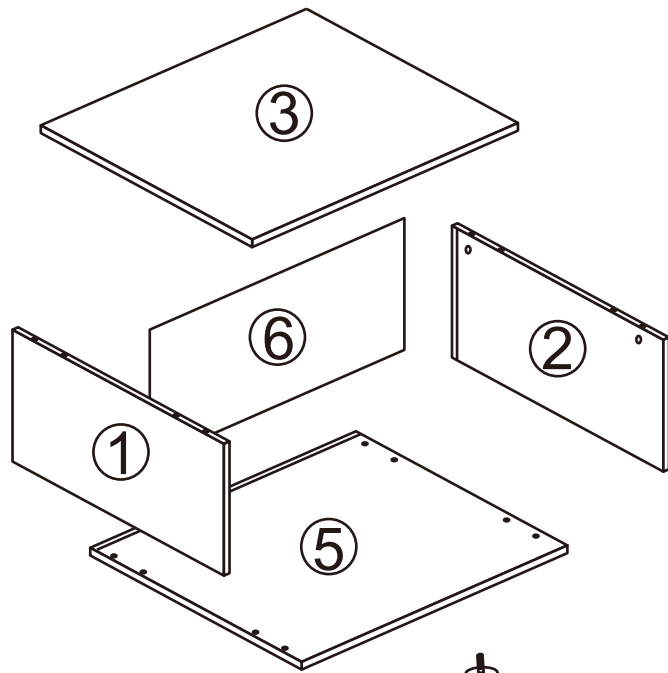













Suppliers of inspiration

[www.birlea.com](http://www.birlea.com)



**Birlea**

Suppliers of inspiration

Parts List				Hardware List		
Part	Description	Box	Qty	Part	Description	Qty
1	Side Panel(Left)	1	1	A	CAM BOLT 	8
2	Side Panel(Right)	1	1	B	CAM LOCK 	8
3	Top Panel	1	1	C	Wooden Dowel 	8
4	Wooden Leg	1	4	D	Screw 	4
5	Bottom Panel	1	1	E	Metal Sheet 	4
6	Back Panel	1	1	F	Screw 	21
7	Drawer Side(Left)	1	1	G	Screw 	10
8	Drawer Side(Right)	1	1	H	Handle+Screw 	1
9	Drawer Back	1	1	I	Plastic Wedge + Screw 	4
10	Drawer Front	1	1	J	Foot pad 	4
11	Drawer Bottom	1	1	K	Hole sticker	4
				L	Washer 	1
				M	Safe strap 	1
				N	Screw 	4
				O	Allen key 	1
				DL	Rail 	1
				DR	Rail 	1
				CL	Rail 	1
				CR	Rail 	1

**\*\* You will need a small mallet and a screwdriver for assembly.**

**\*\* Some screws and wooden dowel may remain.**

**\*\* Note : To secure the item to the wall.**



**Birlea**

Suppliers of inspiration

**Step 1:** Attach drawer back panel(9) to drawer side paanel(7),(8) using hardware D;  
 Attach the bottom panel(11) before assembly the drawer front panel;  
 Attach the drawer front panel(10) by hardware A,B,K;and then,assemble the handle(H);  
 Attach the hardware(DL),(DR) by hardware G.  
**DO NOT use any power tools as this may damage the frame and will invalidate any claim.**

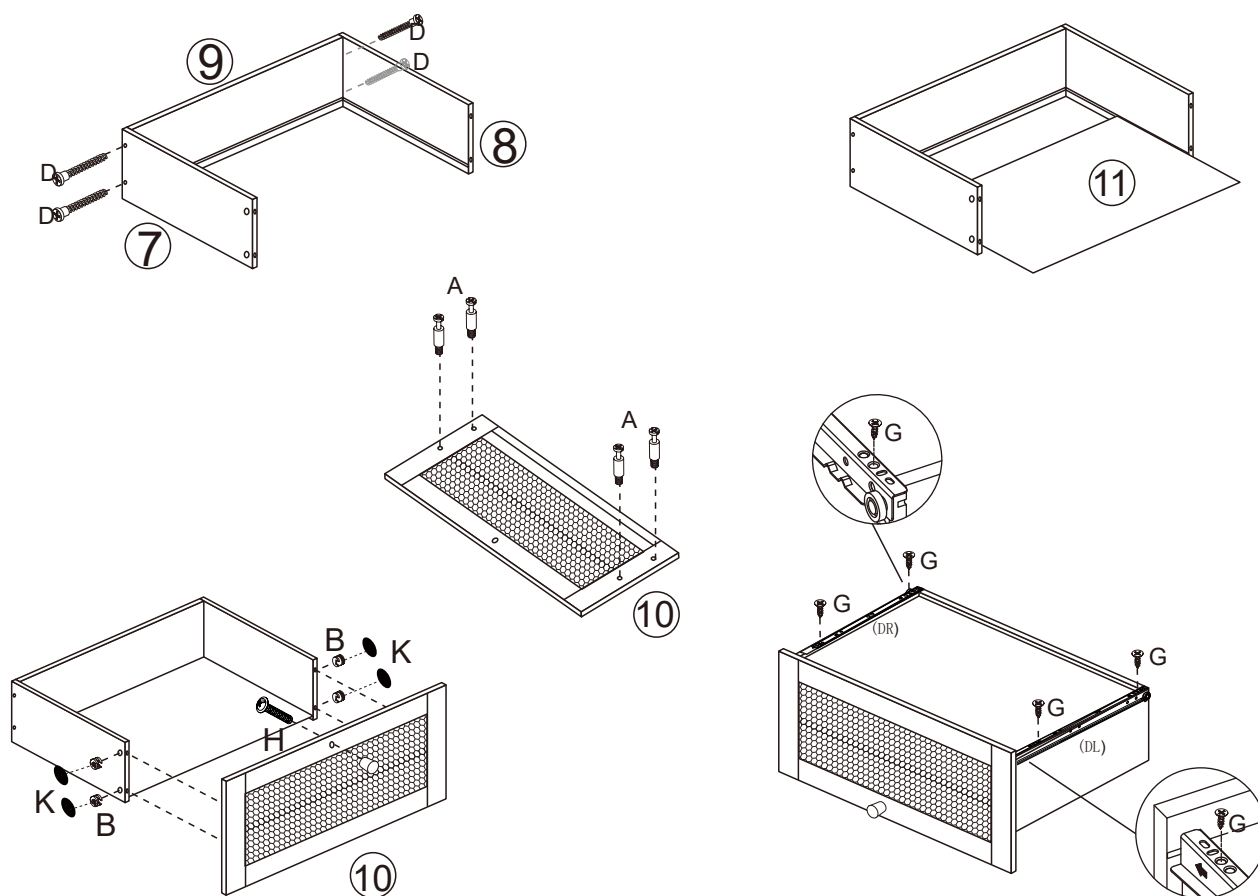

**Step 2:** Attach the hardware(CL),(CR) on side panel(1),(2) by hardware G.  
**DO NOT use any power tools as this may damage the frame and will invalidate any claim.**

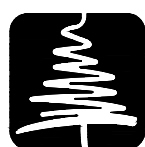
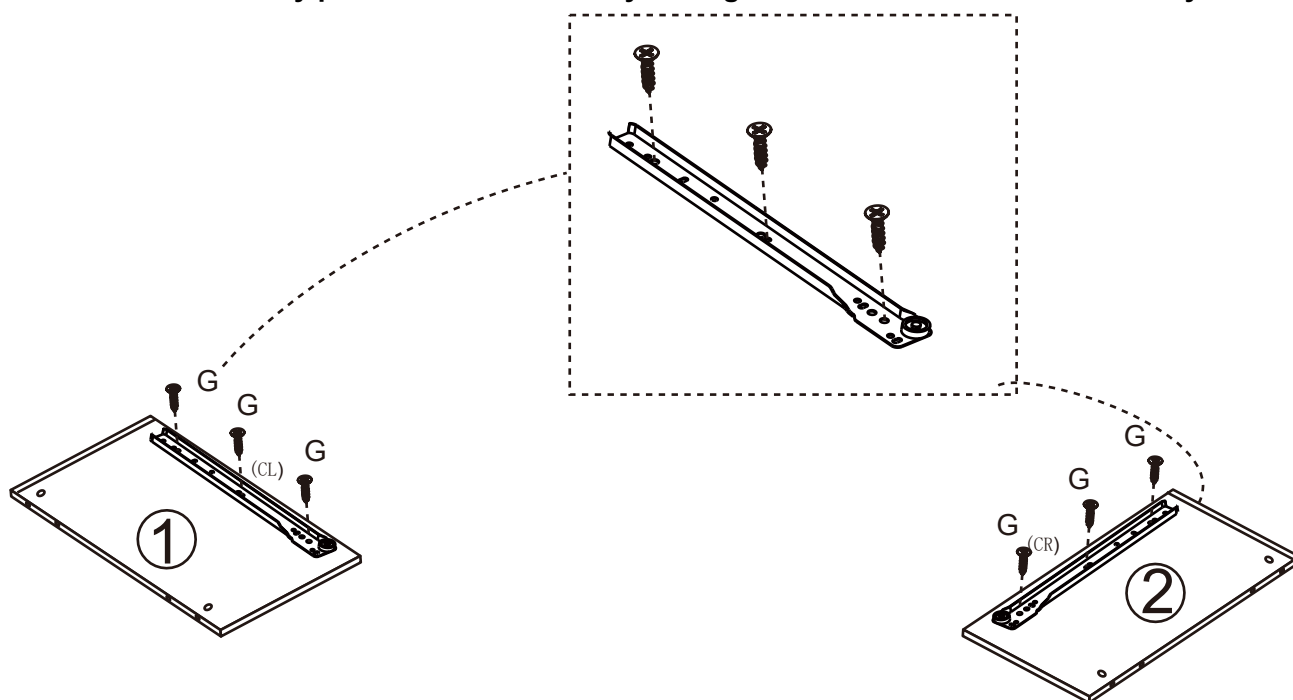

**Birlea**

Suppliers of inspiration

**Step 3:** Assemble top panel(3) with side panel(1),(2) by hardware A,B,C.

**DO NOT use any power tools as this may damage the frame and will invalidate any claim.**

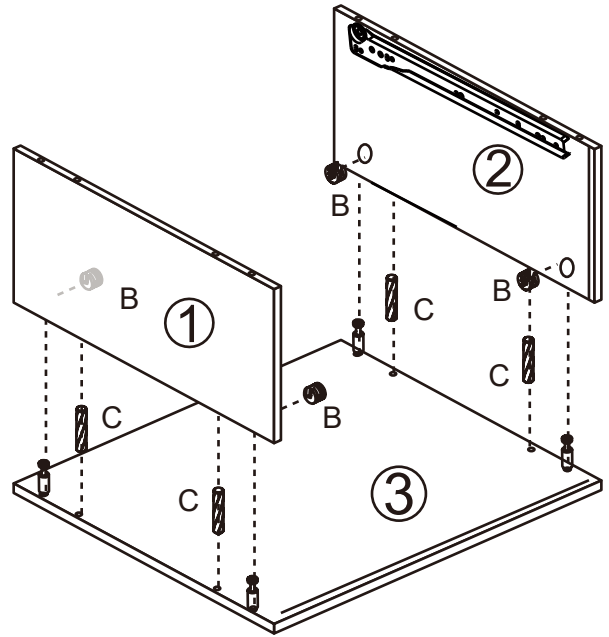
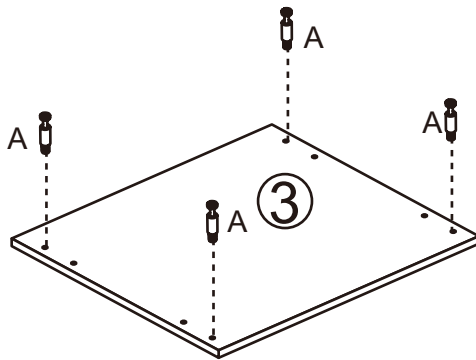

**Step 4:** Attach the back panel(6) before assemble the bottom panel;

Attach the bottom panel(5) by hardware C,N.

**DO NOT use any power tools as this may damage the frame and will invalidate any claim.**

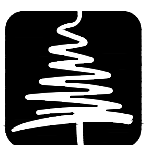
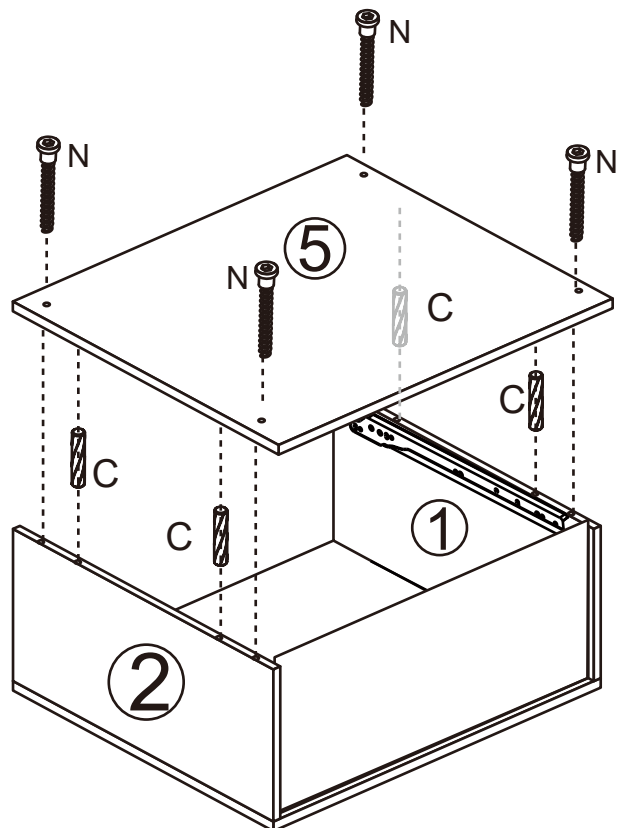
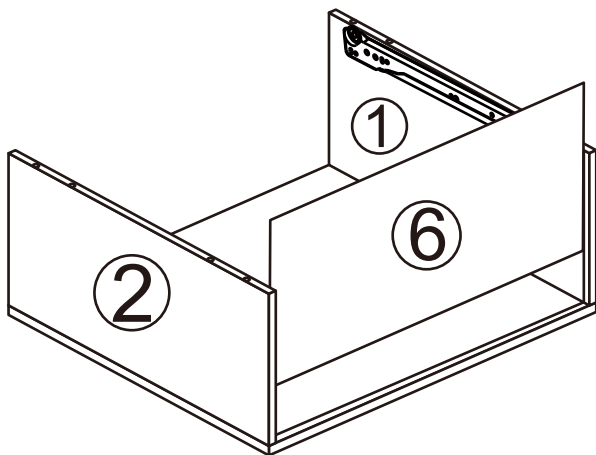

**Birlea**

Suppliers of inspiration

**Step 5:** Attach the leg sheet(E) by hardware F.

**DO NOT use any power tools as this may damage the frame and will invalidate any claim.**

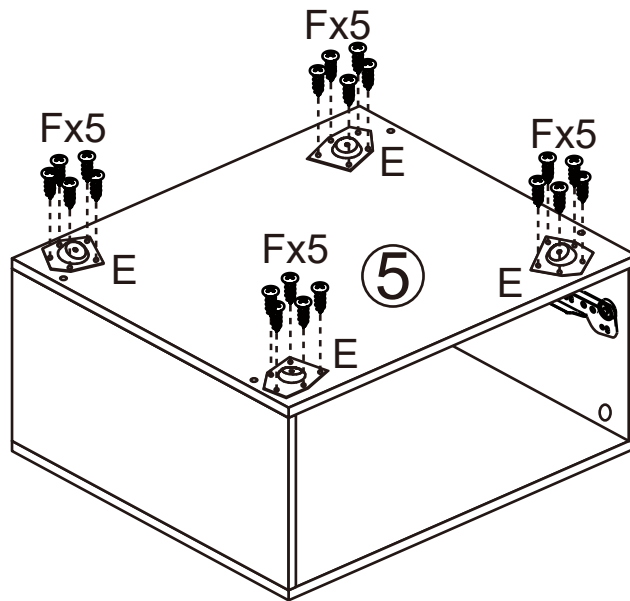

**Step 6:** Attach the legs(4),and then attach the pad(J);

Attach the hardware I on the back of the item.

**DO NOT use any power tools as this may damage the frame and will invalidate any claim.**

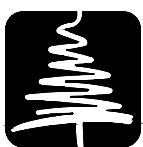
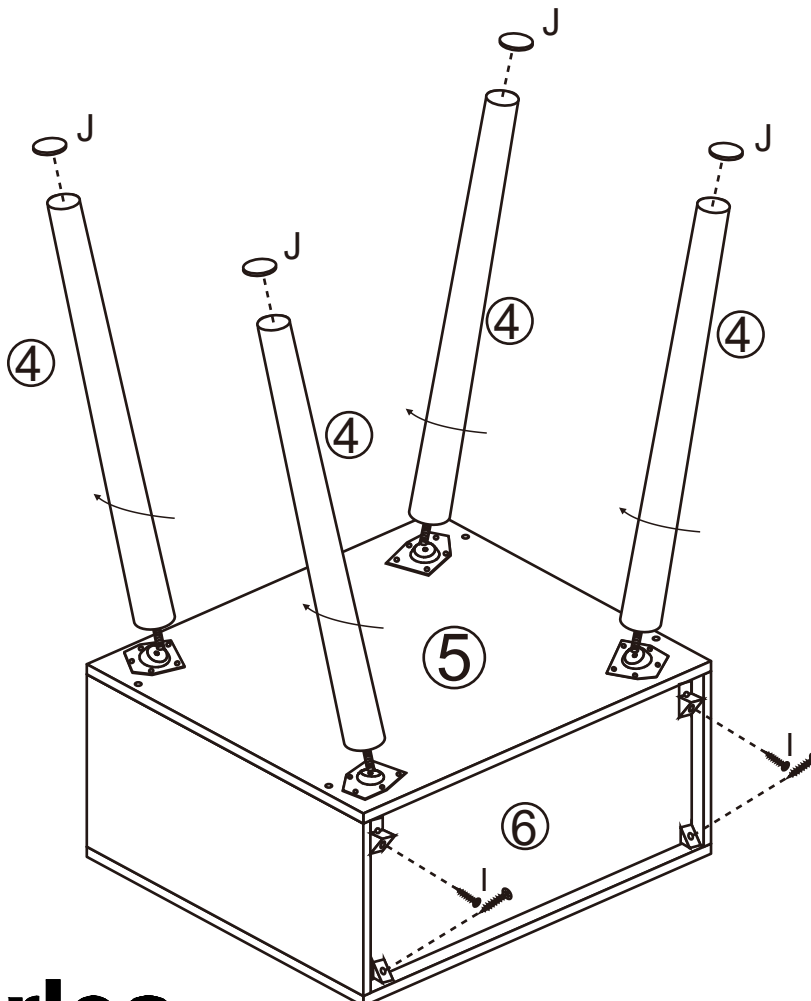

**Birlea**

Suppliers of inspiration

**Step 7:** Secure the safty belt(M) by hardware F,L.

**DO NOT use any power tools as this may damage the frame and will invalidate any claim.**

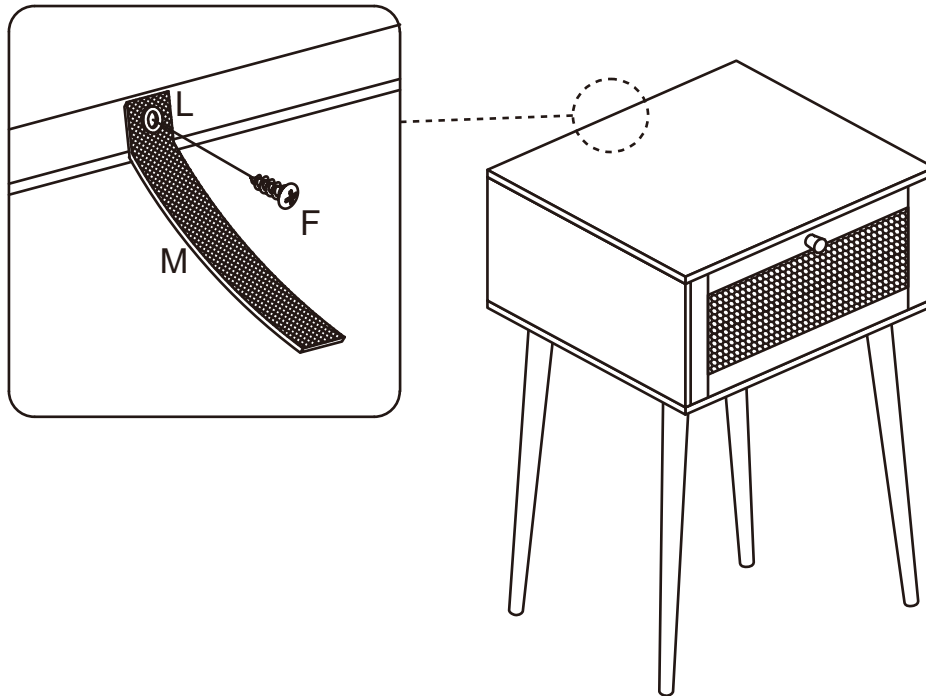

**PLEASE NOTE** that wall fixings are not supplied as different wall materials require different fixing devices. You must use fixings devices suitable for the type of wall you intend to mount product to. Ensure the head of any screw used has a diameter greater than the mounting hole and the fixing is safe and secure before use.

Birlea Furniture advise you use the wall straps provided to further enhance the safety of this product.

### **Additional Information:**

- For complete product information, images and dimension diagrams please visit the website [www.birlea.com](http://www.birlea.com)
- If you have any issues with your item please contact the retailer directly you purchased it from who will be able to resolve any issues with Birlea.
- Why don't you send us photos of your assembled furniture to [info@birlea.com](mailto:info@birlea.com) to be shared in our #birleahome feature on instagram.

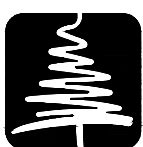

**Birlea**

Suppliers of inspiration